



*Meubles de Qualité à Prix Abordable*  
*Affordable Quality Home Furniture*

BUREAU EN COIN GAUCHE / DROIT STYLE VIEUX BOIS NATUREL  
NATURAL RECLAIMED-LOOK LEFT / RIGHT FACING CORNER DESK

# I 7219

INSTRUCTIONS D'ASSEMBLAGE  
ASSEMBLY INSTRUCTIONS

MONARCH SPECIALTIES INC.









POUR DE L'ASSISTANCE OU POUR COMMANDER  
DES PIÈCES CONTACTEZ NOTRE DÉPARTEMENT  
DE SERVICE À LA CLIENTÈLE.

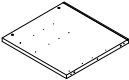
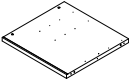
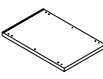
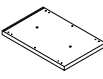
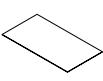



FOR ASSISTANCE OR TO ORDER PARTS  
CONTACT OUR CUSTOMER SERVICE DEPARTMENT

**[WWW.MONARCHSERVICE.COM](http://WWW.MONARCHSERVICE.COM)**



**IDENTIFICATION DES PIÈCES**  
**PARTS IDENTIFICATION**

<b>1</b>		<b>PANNEAU CÔTÉ GAUCHE</b> <b>LEFT SIDE PANEL</b>	<b>1MC</b> <b>1PC</b>
<b>2</b>		<b>PANNEAU CÔTÉ DROIT</b> <b>RIGHT SIDE PANEL</b>	<b>1MC</b> <b>1PC</b>
<b>3</b>		<b>PANNEAU DU BAS</b> <b>BOTTOM PANEL</b>	<b>1MC</b> <b>1PC</b>
<b>4</b>		<b>PANNEAU DU DESSUS</b> <b>TOP PANEL</b>	<b>1MC</b> <b>1PC</b>
<b>5</b>		<b>PANNEAU ARRIÈRE</b> <b>BACK PANEL</b>	<b>1MC</b> <b>1PC</b>
<b>6</b>		<b>PANNEAU DEVANT DU TIROIR</b> <b>DRAWER FRONT PANEL</b>	<b>1MC</b> <b>1PC</b>
<b>7</b>		<b>PANNEAU ARRIÈRE DU TIROIR</b> <b>DRAWER BACK PANEL</b>	<b>1MC</b> <b>1PC</b>
<b>8</b>		<b>PANNEAU CÔTÉ GAUCHE DU TIROIR</b> <b>LEFT DRAWER SIDE PANEL</b>	<b>1MC</b> <b>1PC</b>
<b>9</b>		<b>PANNEAU CÔTÉ DROIT DU TIROIR</b> <b>RIGHT DRAWER SIDE PANEL</b>	<b>1MC</b> <b>1PC</b>
<b>10</b>		<b>PANNEAU DU FOND DU TIROIR</b> <b>DRAWER BOTTOM PANEL</b>	<b>2MCX</b> <b>2PCS</b>

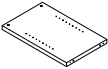
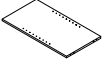
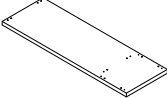
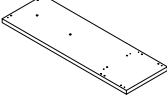
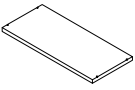
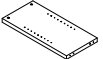

**IDENTIFICATION DES PIÈCES**  
**PARTS IDENTIFICATION**

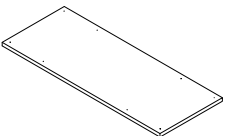
<b>11</b>		<b>PANNEAU DEVANT DU TIROIR DRAWER FRONT PANEL</b>	<b>2MCX 2PCS</b>
<b>12</b>		<b>PANNEAU ARRIÈRE DU TIROIR DRAWER BACK PANEL</b>	<b>2MCX 2PCS</b>
<b>13</b>		<b>PANNEAU CÔTÉ GAUCHE DU TIROIR LEFT DRAWER SIDE PANEL</b>	<b>2MCX 2PCS</b>
<b>14</b>		<b>PANNEAU CÔTÉ DROIT DU TIROIR RIGHT DRAWER SIDE PANEL</b>	<b>2MCX 2PCS</b>
<b>15</b>		<b>PANNEAU CÔTÉ GAUCHE LEFT SIDE PANEL</b>	<b>1MC 1PC</b>
<b>16</b>		<b>PANNEAU CÔTÉ DROIT RIGHT SIDE PANEL</b>	<b>1MC 1PC</b>
<b>17</b>		<b>PANNEAU DU BAS BOTTOM PANEL</b>	<b>1MC 1PC</b>
<b>18</b>		<b>PANNEAU DU DESSUS TOP PANEL</b>	<b>1MC 1PC</b>
<b>19</b>		<b>PANNEAU AJUSTABLE ADJUSTABLE PANEL</b>	<b>1MC 1PC</b>
<b>20</b>		<b>PANNEAU DE DIVISION DIVIDER PANEL</b>	<b>2MCX 2PCS</b>

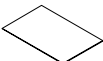



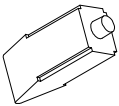
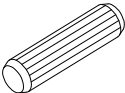
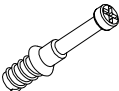

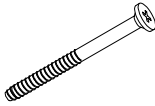

**IDENTIFICATION DES PIÈCES**  
**PARTS IDENTIFICATION**

<b>21</b>		<b>PANNEAU AJUSTABLE ADJUSTABLE PANEL</b>	<b>2MCX 2PCS</b>
<b>22</b>		<b>DESSUS DE TABLE TABLE TOP</b>	<b>1MC 1PC</b>
<b>23</b>		<b>PANNEAU DE TABLE DE CLOISON TABLE TOP PARTITION BOARD</b>	<b>2MCX 2PCS</b>
<b>24</b>		<b>PANNEAU DU FOND DU TIROIR DRAWER BOTTOM PANEL</b>	<b>1MC 1PC</b>

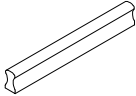
**IDENTIFICATION DES PIÈCES DE MONTAGE**  
**HARDWARE IDENTIFICATION**

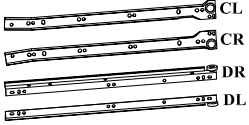
<b>A</b>		<b>COLLE/GLUE(40g)</b>	<b>1MC/PC</b>
<b>B</b>		<b>ø8x30mm</b>	<b>34MCX/PCS</b>
<b>C</b>		<b>35.5mm</b>	<b>18MCX/PCS</b>
<b>D</b>		<b>ø15x12mm</b>	<b>18MCX/PCS</b>

**IDENTIFICATION DES PIÈCES DE MONTAGE**  
**HARDWARE IDENTIFICATION**

<b>E</b>		35mm	20MCX/PCS
<b>F</b>		55mm	14MCX/PCS
<b>G</b>		ø4.9x15mm	12MCX/PCS
<b>H</b>		L 120mm	3MCX/PCS
<b>I</b>		22.5mm	6MCX/PCS
<b>J</b>		L 400mm	2ENS/SET
<b>K</b>		10mm	42MCX/PCS
<b>L</b>		50x50x18mm	9MCX/PCS
<b>M</b>		25.5mm	18MCX/PCS
<b>N</b>		M6x38mm	4MCX/PCS

**IDENTIFICATION DES PIÈCES DE MONTAGE**  
**HARDWARE IDENTIFICATION**

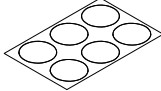
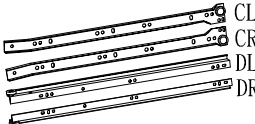
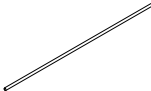
<b>O</b>		$\phi 20\text{mm}$	<b>3MCX/PCS</b>
<b>P</b>		<b>L 450mm</b>	<b>1ENS/SET</b>
<b>Q</b>		$\phi 4.8 \times 293\text{mm}$	<b>2MCX/PCS</b>

**ÉTAPE / STEP 1**

La colle (A) doit être utilisée aux endroits indiqués afin de solidifier l'étagère assemblée.  
 The Glue (A) should be used in the indicated locations to help solidify the assembled unit.

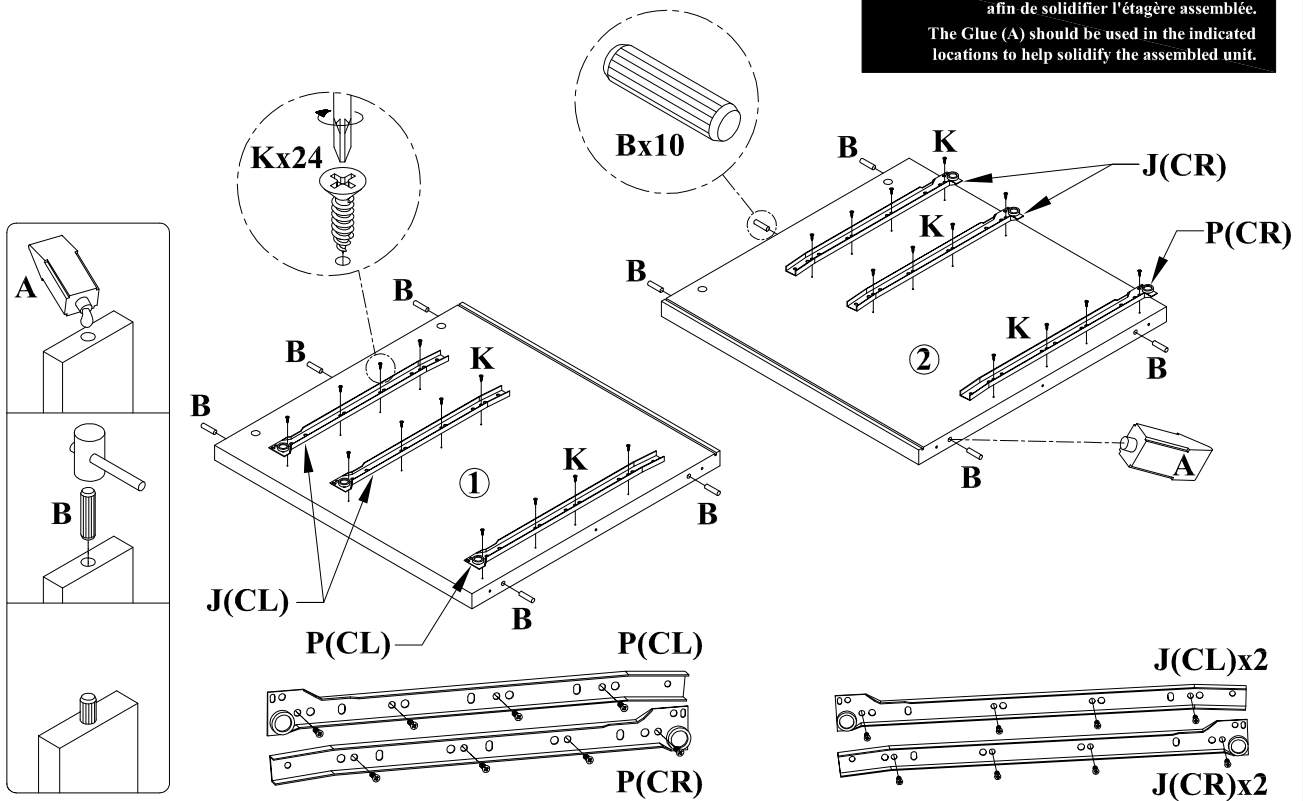

ÉTAPE / STEP 2

La colle (A) doit être utilisée aux endroits indiqués afin de solidifier l'étagère assemblée.  
 The Glue (A) should be used in the indicated locations to help solidify the assembled unit.

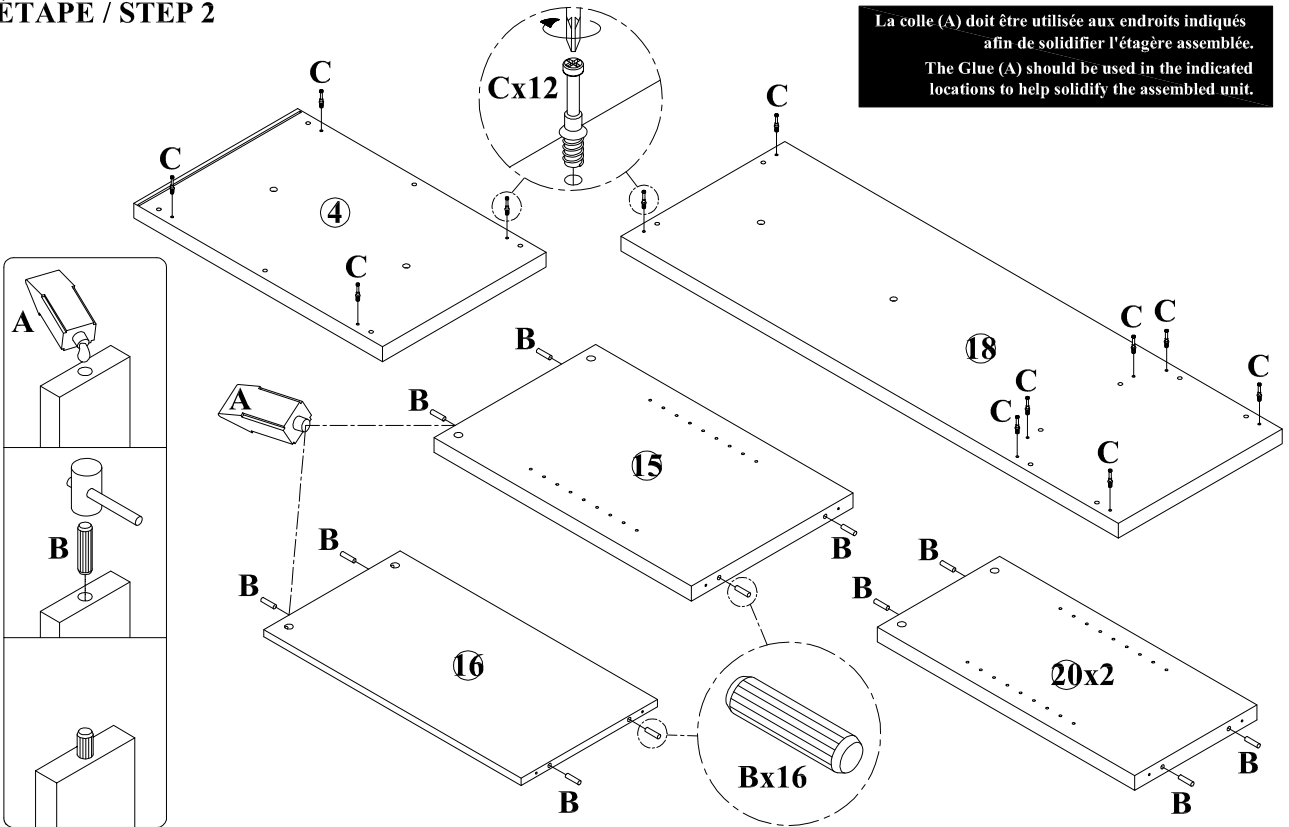

ÉTAPE / STEP 3

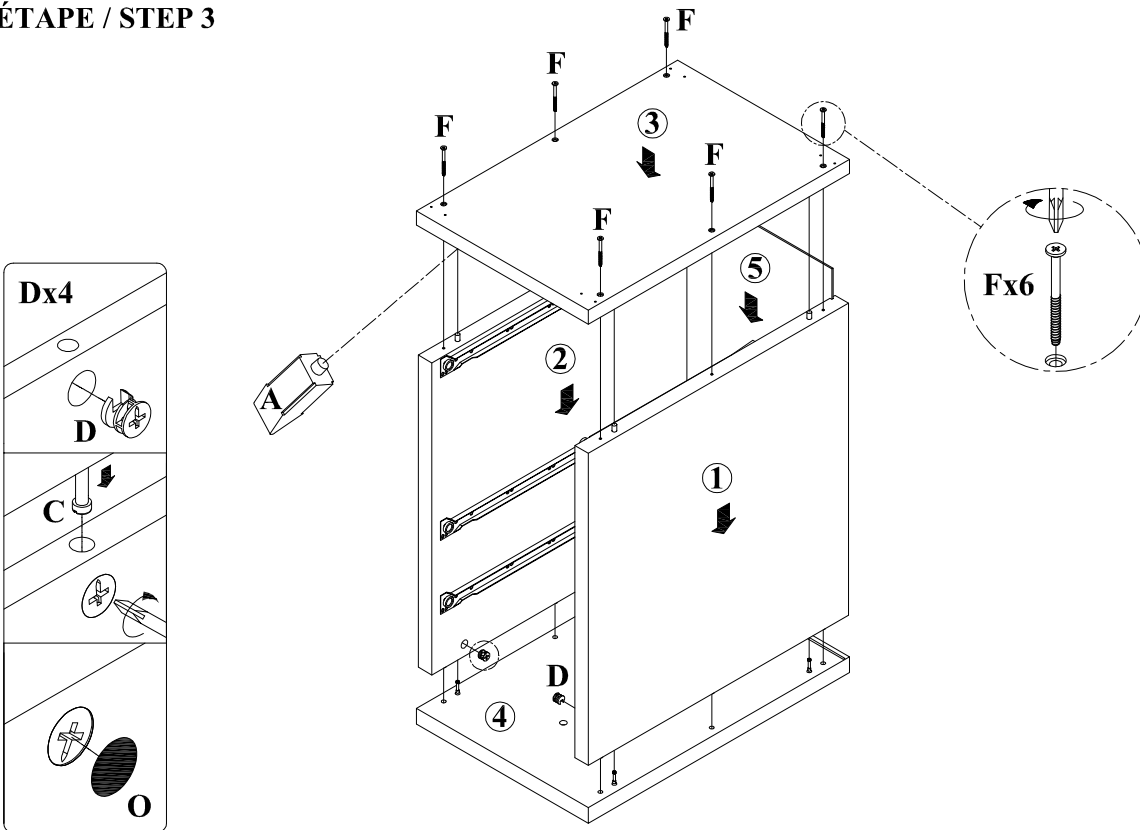

ÉTAPE / STEP 4

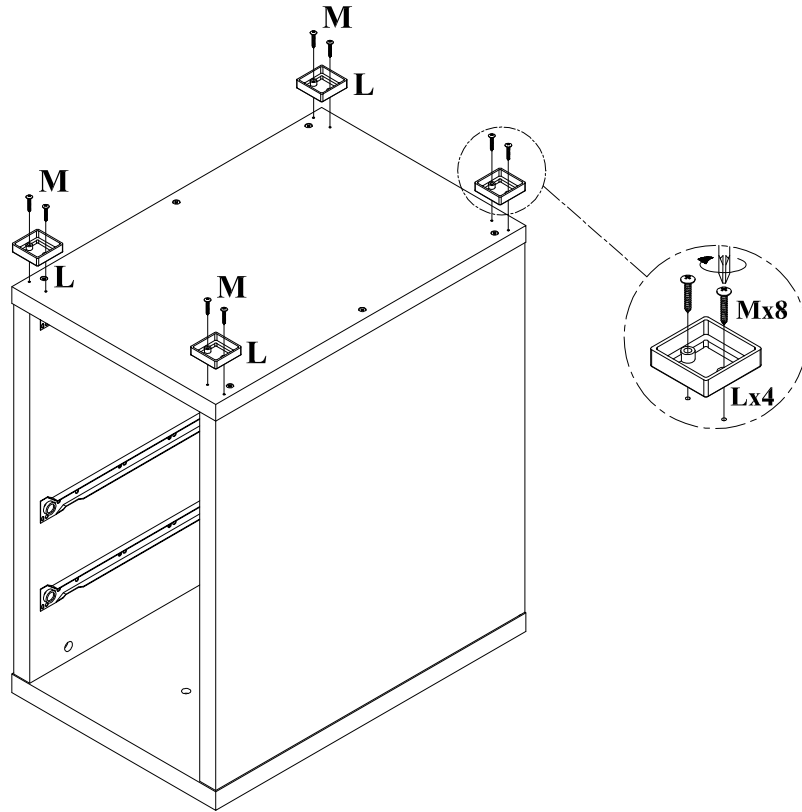

ÉTAPE / STEP 5

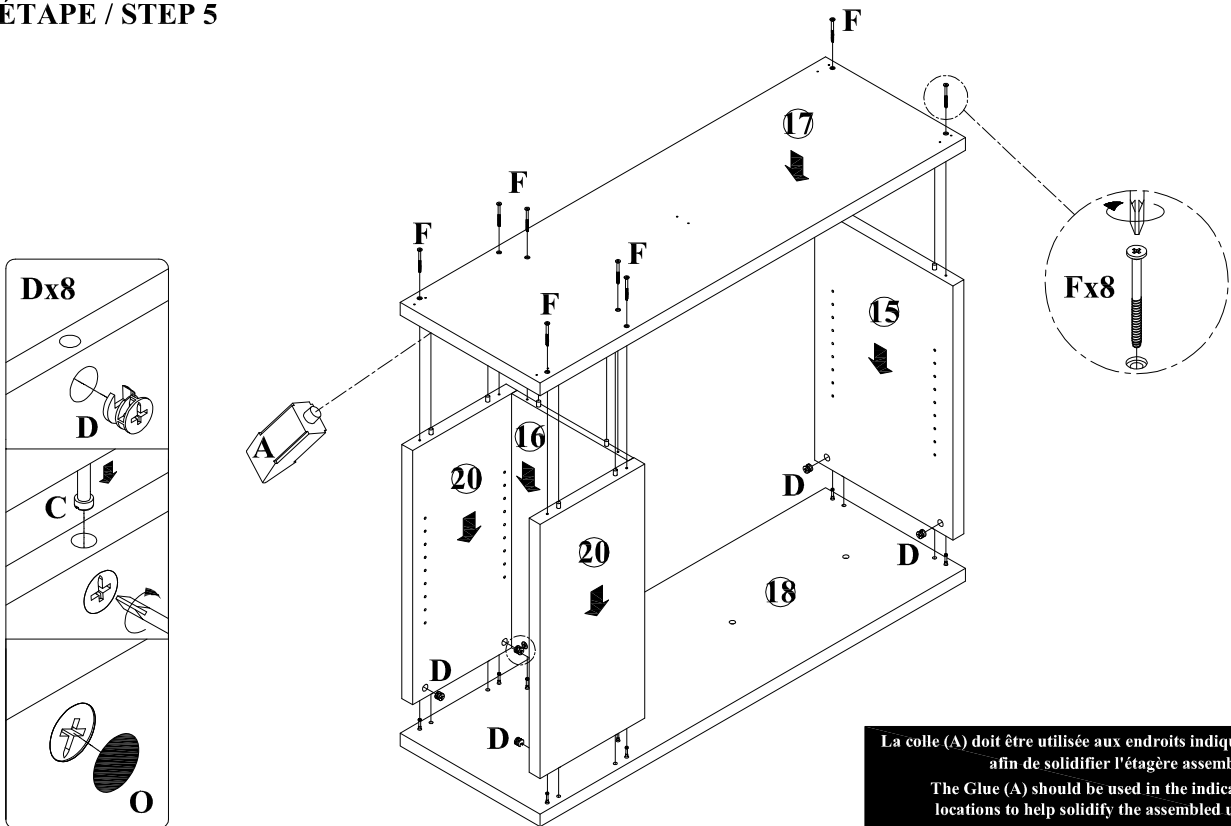

La colle (A) doit être utilisée aux endroits indiqués afin de solidifier l'étagère assemblée.  
 The Glue (A) should be used in the indicated locations to help solidify the assembled unit.



ÉTAPE / STEP 6

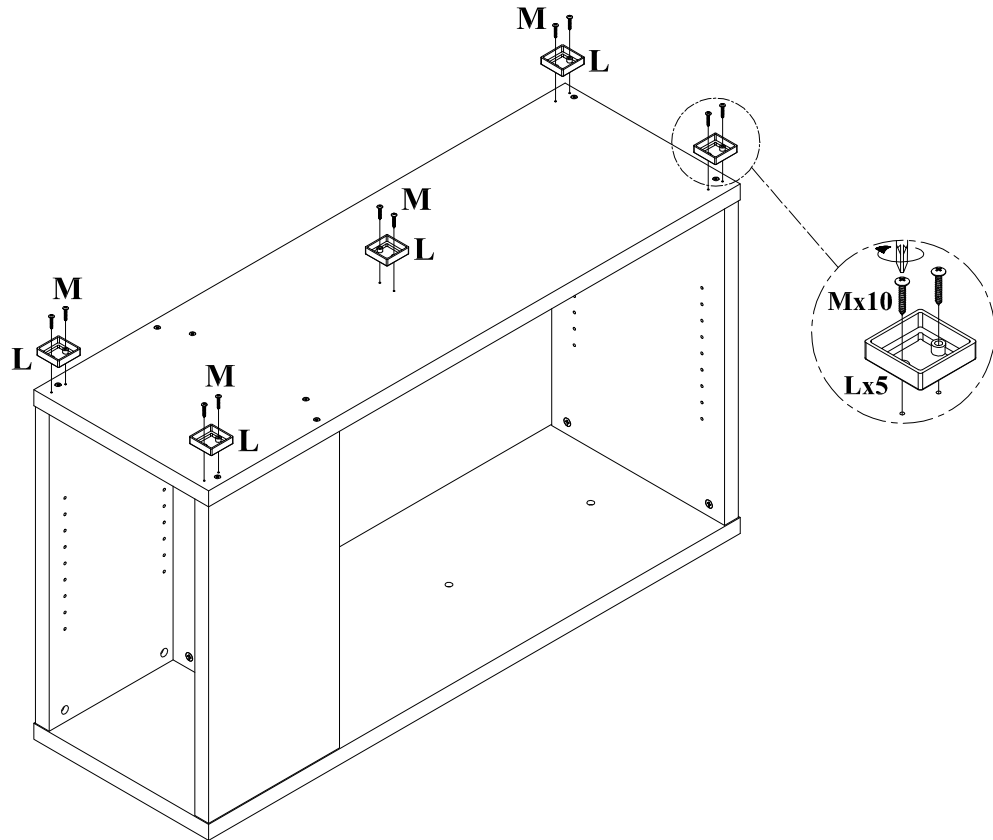

ÉTAPE / STEP 7

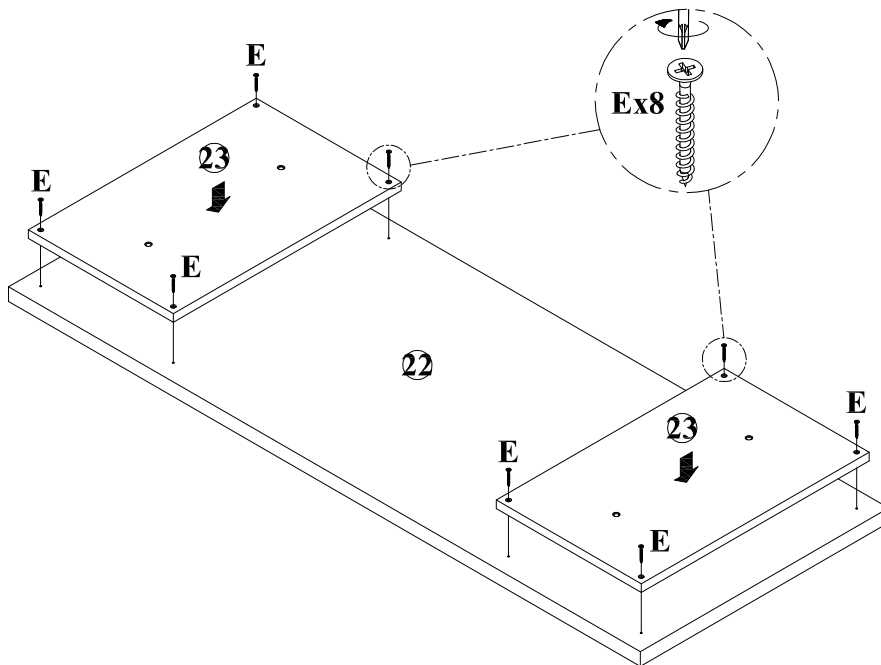

ÉTAPE / STEP 8

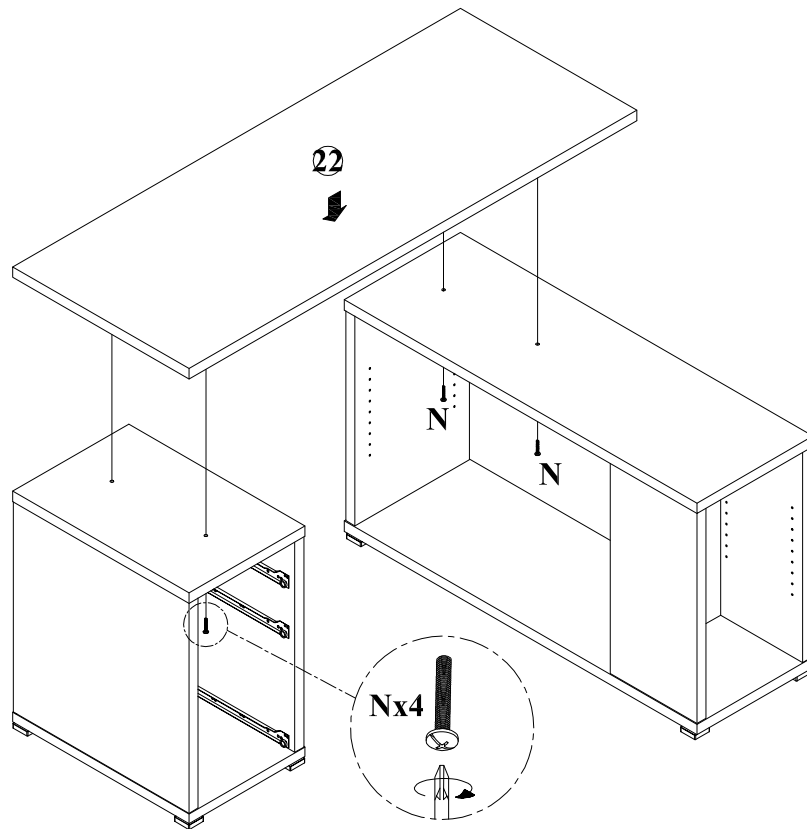

ÉTAPE / STEP 9

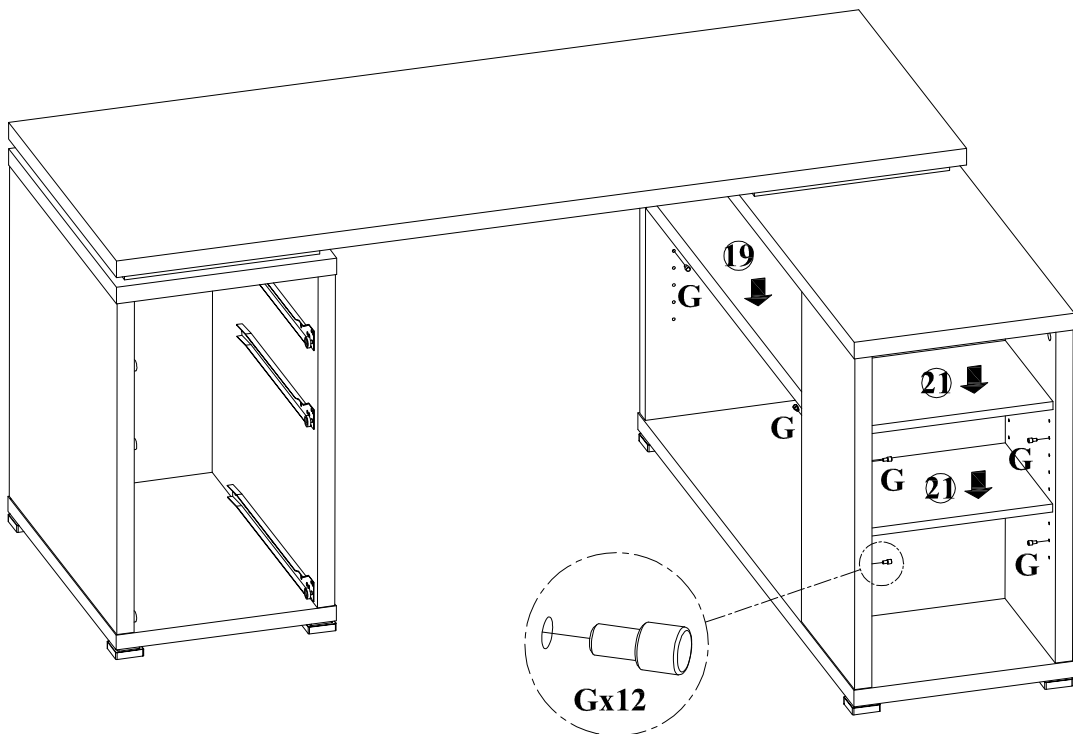

ÉTAPE / STEP 10

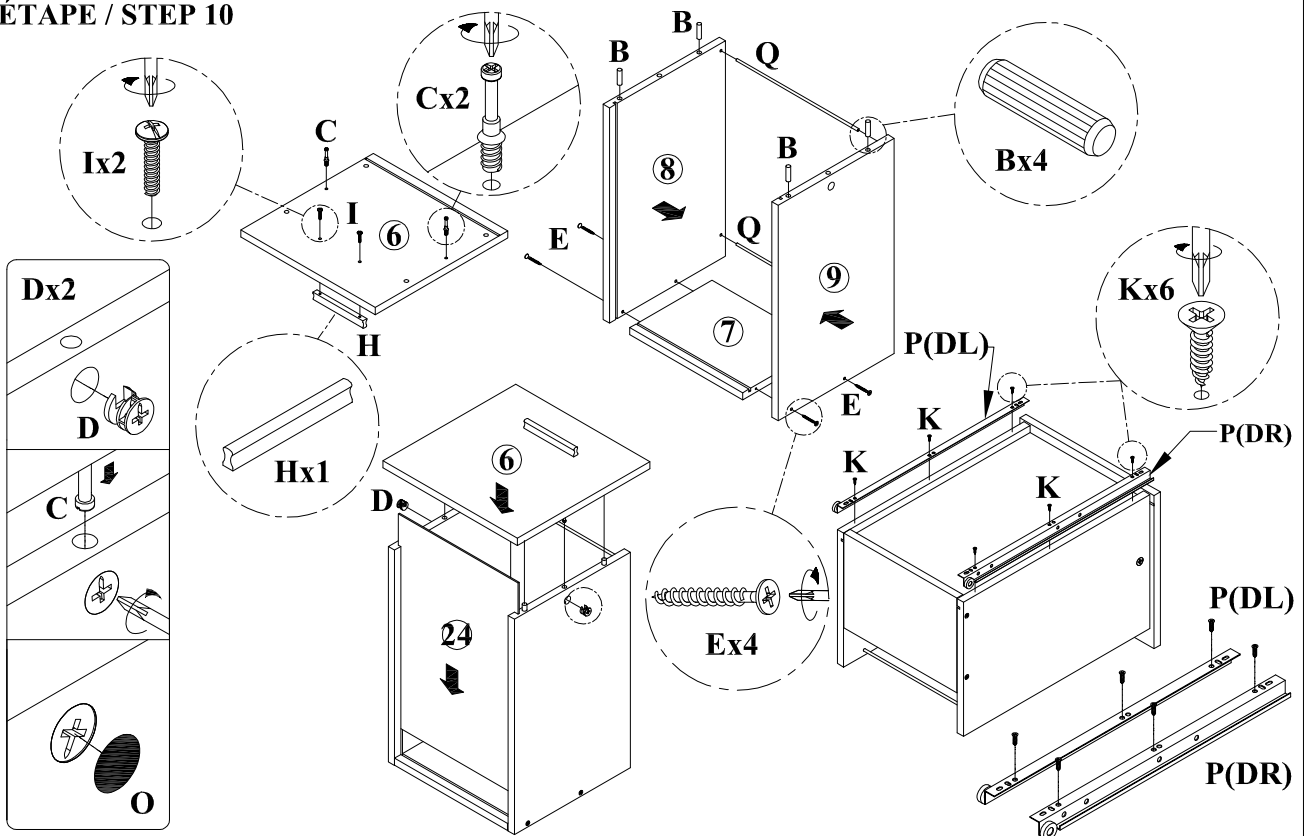

ÉTAPE / STEP 11

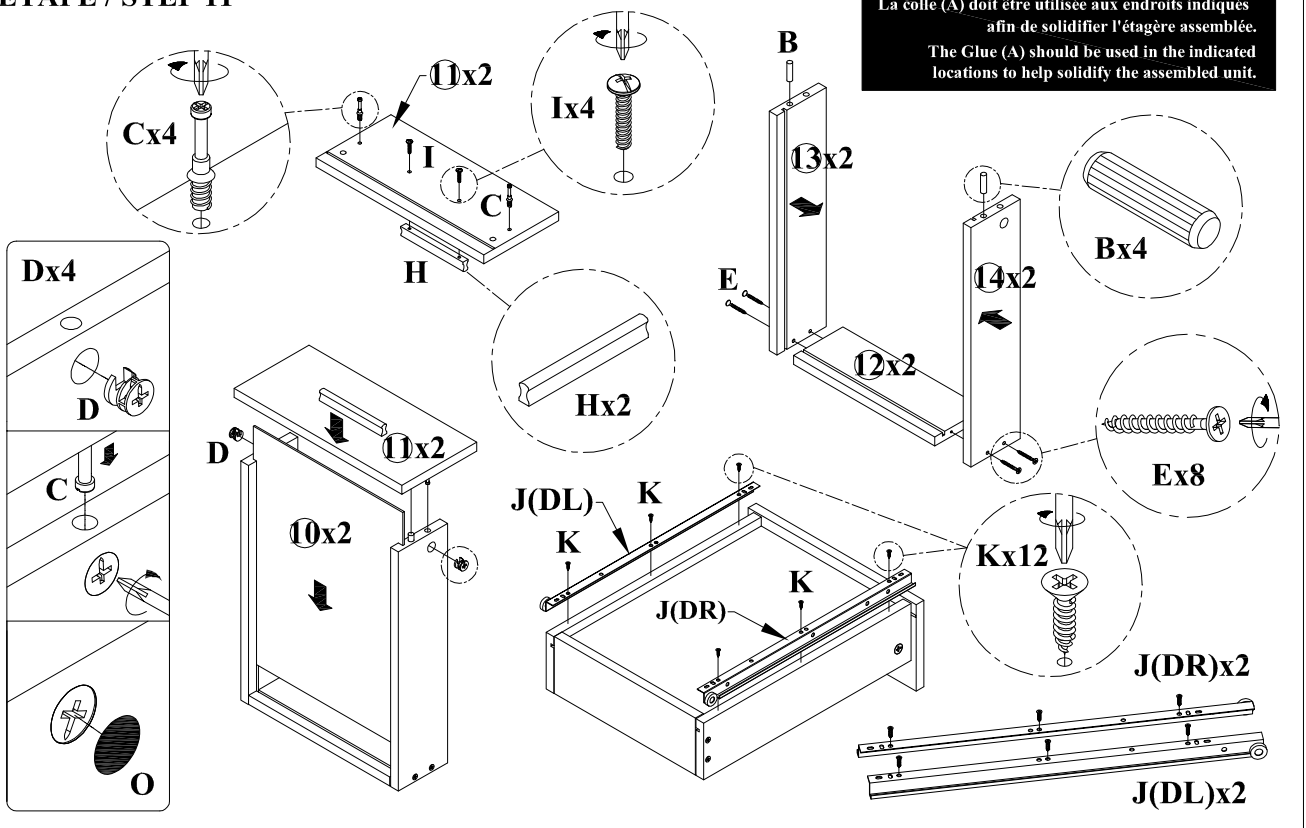

ARTICLE: **I 7219**  
ITEM:

INSTRUCTIONS D'ASSEMBLAGE  
ASSEMBLY INSTRUCTIONS

**ÉTAPE / STEP 12**

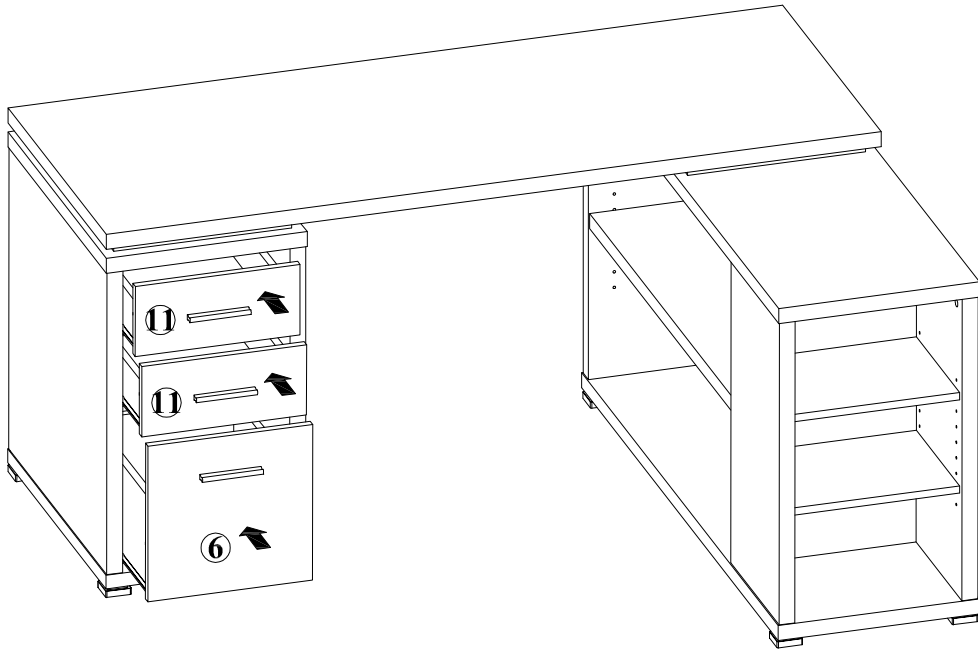

**TERMINER / FINISH**

